

MX15-4-100 Laser Driver and Thermal Management Module
100A, 4V, 10Hz output; 10VDC to 36VDC input

Datasheet

LDTM

MX15-4-100 LDTM, P/N 7052-1100-80

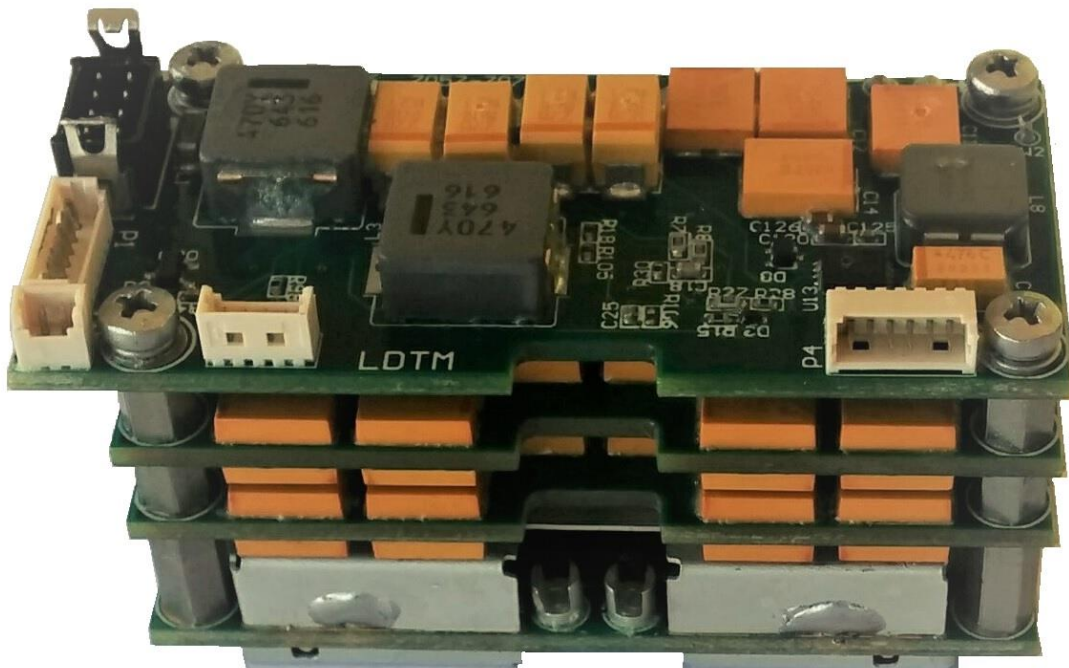

MX15-4-100 Laser Driver and Thermal Management Module

100A, 4V, 10Hz output; 10VDC to 36VDC input

MX15-2-100 LDTM, P/N 7052-1100-80

Applications

- Solid-state diode pumped laser driver
- Airborne applications
- Ground and maritime applications

Standards

- MIL-461G
- MIL-1275, with external protection circuit
- MIL-704
- MIL-810
- MIL-217F

Features

- Wide input voltage range, 10VDC to 35VDC
- Constant input power over input voltage range
- Current source topology
- Adjustable output current
- Low consumption current at idle mode
- High efficiency
- No cooling required
- Output overvoltage/open circuit protection
- Wide operating temperature range, -40°C to +75°C
- Adjustable TEC driver

MX15-4-100 Laser Driver and Thermal Management Module

100A, 4V, 10Hz output; 10VDC to 36VDC input

Description

The LDTM is non-isolated pulse current source that can deliver up to 110A output current at up to 7V during 3.2mS. nFIRE low state defines the output current pulse width. Maximum pulse width at 100A can be as long as 3.2

ms. The module operates from DC voltage in range from 10VDC to 35VDC. Maximum consumption current is limited to 4A. As higher input voltage as

lower maximum consumption current. The charger converts input voltage to current and charges bulk capacitor to nominal voltage. The bulk capacitor stores an energy required to generate output current pulse.

Fig 1, LDTM Block Diagram

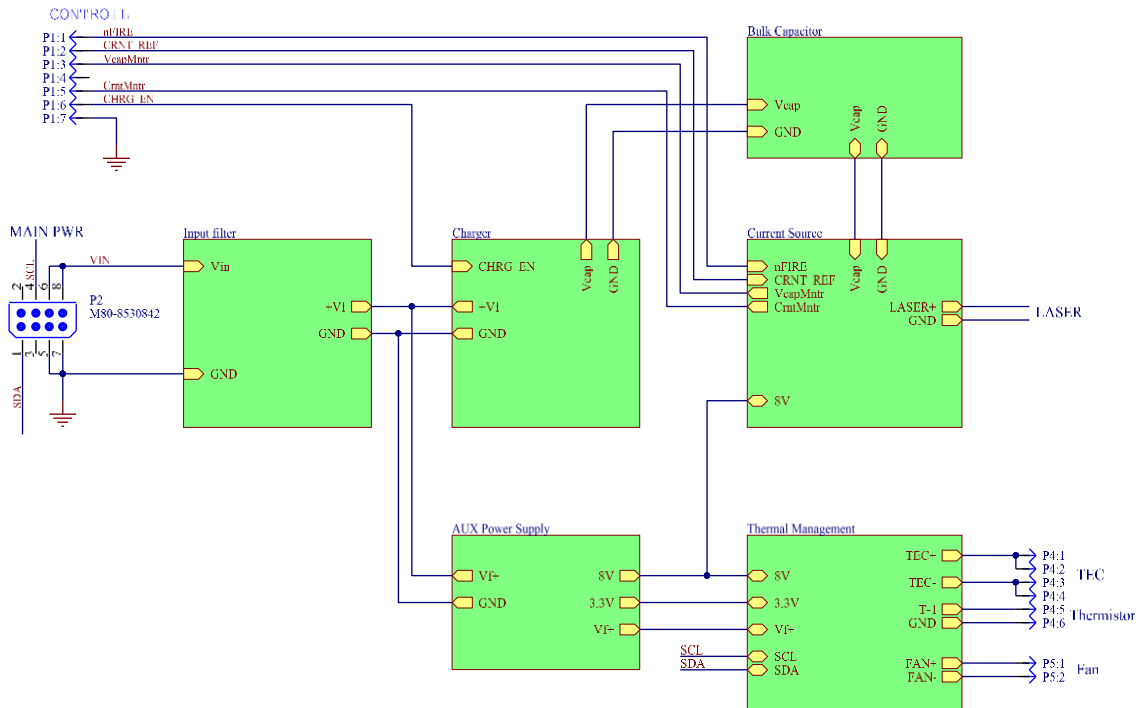

MX15-4-100 Laser Driver and Thermal Management Module

100A, 4V, 10Hz output; 10VDC to 36VDC input

Absolute Maximum Ratings

Parameter	Symbol	Min	Max	Unit
Input Voltage	V_{in}	-0.3	36	Vdc
SCL, SDA Lines	V_{I2C}	-0.3	3.3	Vdc
nFIRE line	V_{FIRE}	-0.3	8	Vdc
CRNT_REF line	V_{ref}	-0.3	5	Vdc
Operating Ambient Temperature	T_a	-40	75	°C
Storage Temperature	T_{stg}	-55	85	°C
Operating Altitude	H_{op}	-500	15000	m

CAUTION: This power module is not internally fused.

MX15-4-100 Laser Driver and Thermal Management Module

100A, 4V, 10Hz output; 10VDC to 36VDC input

Electrical Specification

Unless otherwise indicated, specifications apply over all operating input voltage, resistive load, and temperature conditions.

Parameter	Symbol	Min	Typ	Max	Unit
Power					
Input Voltage	V_{in}	10	28	35	Vdc
Maximum Input Current, @ $V_{in} = 10V$	I_{INmax}			2	Adc
Output Current, adjustable	I_{out}	80	100	110	Adc
Output Current Pulse Width, $I_{out} = 100A$	t_{pw}	3.2			mS
Current pulses repetition rate				10	pps
Idle mode consumption current $V_{in} = 10V$ $V_{in} = 28V$ $V_{in} = 35V$	I_{idle}		16 6 5		mA
Signal Interface					
nFIRE line Threshold	V_{FIRE}			0.4	Vdc
CRNT_REF, $I_{out} = 100A$	V_{ref}		410		mV
CHRG_EN Threshold	$V_{ch.en}$	2.5			V
Energy storage					
Nominal Bulk Capacitor Voltage	V_{bulk}	37.5	39	40.5	Vdc
Nominal Capacitance			3940		μF
Stored Energy	E_{bulk}	3.0			J
Current Source					
Output ripple current, $I_{out} = 100A$	$I_{rip,p-p}$		0.8		A
Case Temperature Rise @25°C @1pps @5pps	ΔT		8 17		°C
Switching Frequency	f_{sw}		333		kHz
Charger					
Input power mode			40		W
Charging Time from 0 to V_{bulk} , @ $V_{in} = 15V$ @ $V_{in} = 28V$ @ $V_{in} = 35V$	t_{chrg}		75 62 78		mS

MX15-4-100 Laser Driver and Thermal Management Module

100A, 4V, 10Hz output; 10VDC to 36VDC input

Electrical Specification (continued)

Unless otherwise indicated, specifications apply over all operating input voltage, resistive load, and temperature conditions.

Parameter	Symbol	Min	Typ	Max	Unit
Thermal Management					
Output Voltage, adjustable	V_{tm}	3.5	5	9	Vdc
Maximum Output Current	I_{TMmax}			1.5	Adc
Efficiency	E_{TM}	90			%

Interfaces, electrical connection

Fig 2. LDTM top view

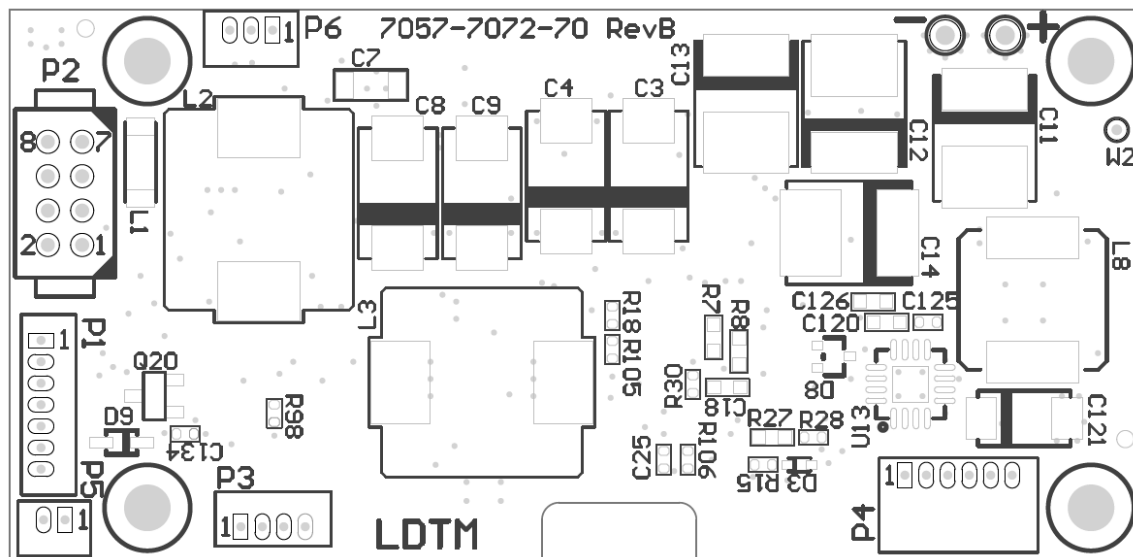

- P1 – Control lines connector
- P2 – Main power and communication connector
- P3 – Programming and temperature sensor connector
- P4 – TEC and temperature sensor connector
- P5 – Fan connector
- P6 – RS232 connector (optional)

MX15-4-100 Laser Driver and Thermal Management Module

100A, 4V, 10Hz output; 10VDC to 36VDC input

Interfaces, electrical connection (continued)

P1 – MOLEX, PN 53047-0710

Pin	Direction	Name	Description
1	Input	nFIRE	Active low, output current enable control, internal pull-up to 3.3V via 10kΩ
2	Input	CRNT_REF	Voltage from low output impedance source to adjust output current
3	Output	VCAP	Bulk capacitor voltage monitor. Passes through 2.7kΩ
4	NA	NU	Not used
5	Output	CRNT_MNTR	Output current monitor
6	Input	CHARGE_EN	Active high, enables bulk capacitor charger
7	Power	GND	Module ground line

P2 – HARWIN, PN M80-8530842

Pin	Direction	Name	Description
1	Input	MOSI/SDA	SPI or I2C communication
2	Input	SPICLK	SPI Clock
3	Input	SPISTE	SPI Select line
4	Bi-directional	MISO/SCL	SPI or I2C communication
5	Power	VIN	Input voltage, 10-35VDC, up to 4A
6	Power	GND	Module ground line
7	Power	VIN	Input voltage, 10-35VDC, up to 4A
8	Power	GND	Module ground line

P3 – MOLEX, PN 53047-0410

Pin	Direction	Name	Description
1	Power	GND	Module ground line
2	Bi-directional	SBWTDIO	CPU programming line, keep float
3	Input	SBWTCK	CPU programming line, keep float
4	Input	THERM1	External thermistor, optional, keep open if not in used

MX15-4-100 Laser Driver and Thermal Management Module

100A, 4V, 10Hz output; 10VDC to 36VDC input

Interfaces, electrical connection (continued)

P4 – MOLEX, PN 053048-0610

Pin	Direction	Name	Description
1	Power	TEC-P	TEC driver output positive line
2	Power	TEC-P	TEC driver output positive line
3	Power	TEC-N	TEC driver output negative line
4	Power	TEC-N	TEC driver output negative line
5	Input	TEC-T-1	Thermistor
6	Power	GND	Module ground line

P5 – MOLEX, PN 53047-0210

Pin	Direction	Name	Description
1	Power	FAN-P	Fan positive line, filtered input voltage
2	Power	FAN-N	Fan negative line, open collector output

P6 – MOLEX, PN 53047-0310 (optional)

Pin	Direction	Name	Description
1	Output	RS232 TX	UART, RS232 data transmit
2	Input	RS232 RX	UART, RS232 data receive
3	Power	GND	Module ground line

MX15-4-100 Laser Driver and Thermal Management Module

100A, 4V, 10Hz output; 10VDC to 36VDC input

Mechanical specification

Dimensions	67x32x36 mm (LxWxH)
Weight	125g
Interface	M2.5x0.45 x 4

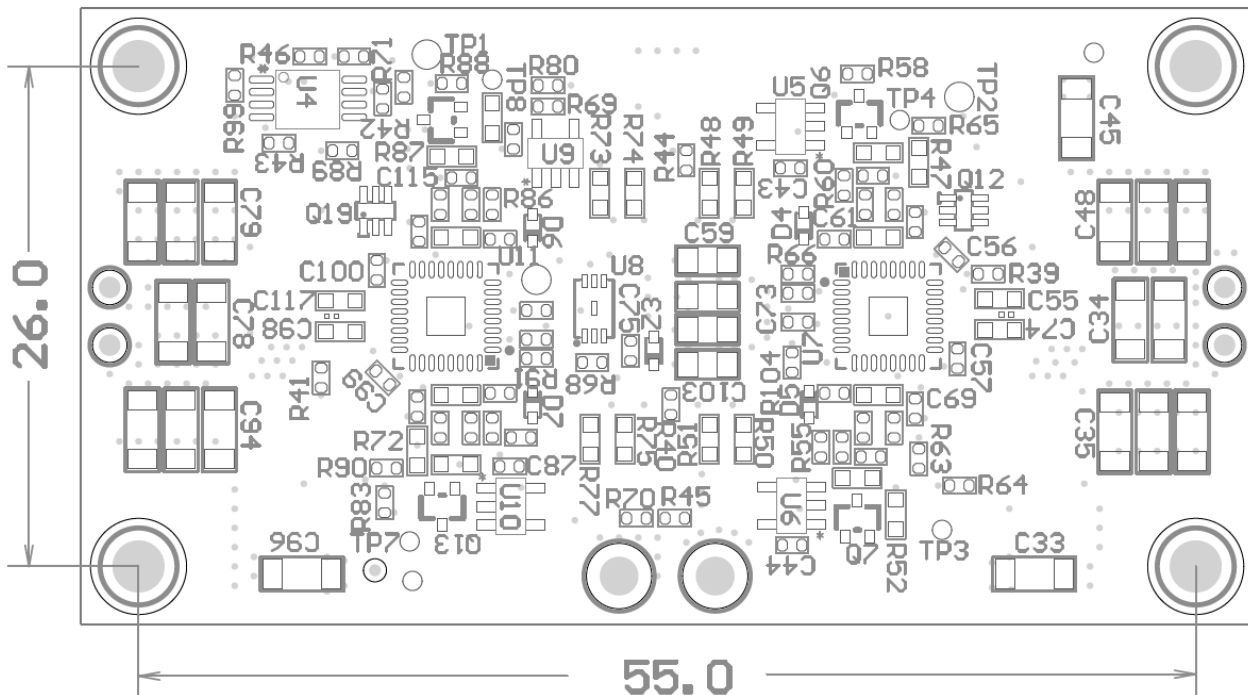

MX15-4-100 Laser Driver and Thermal Management Module

100A, 4V, 10Hz output; 10VDC to 36VDC input

Characteristic Curves

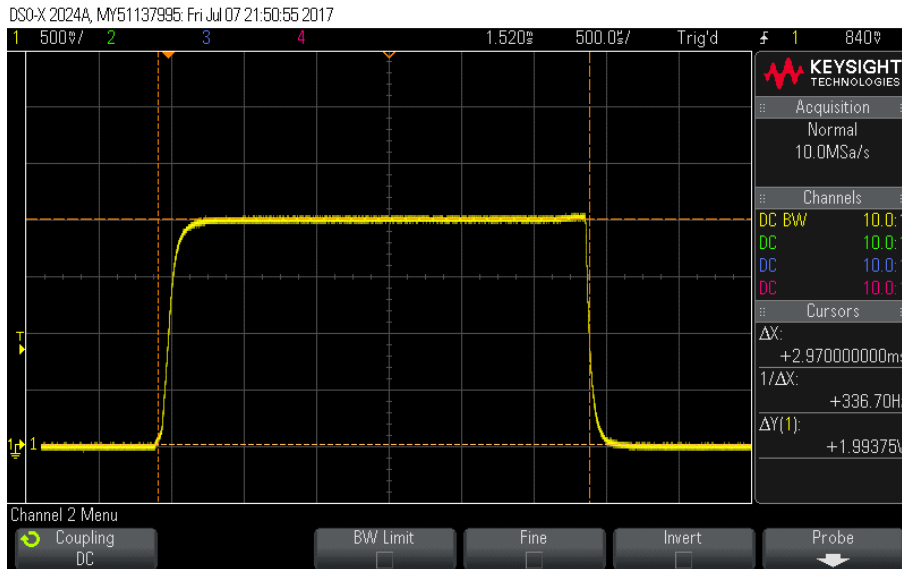

Output current 25A/dev, Resistive Load 40mΩ

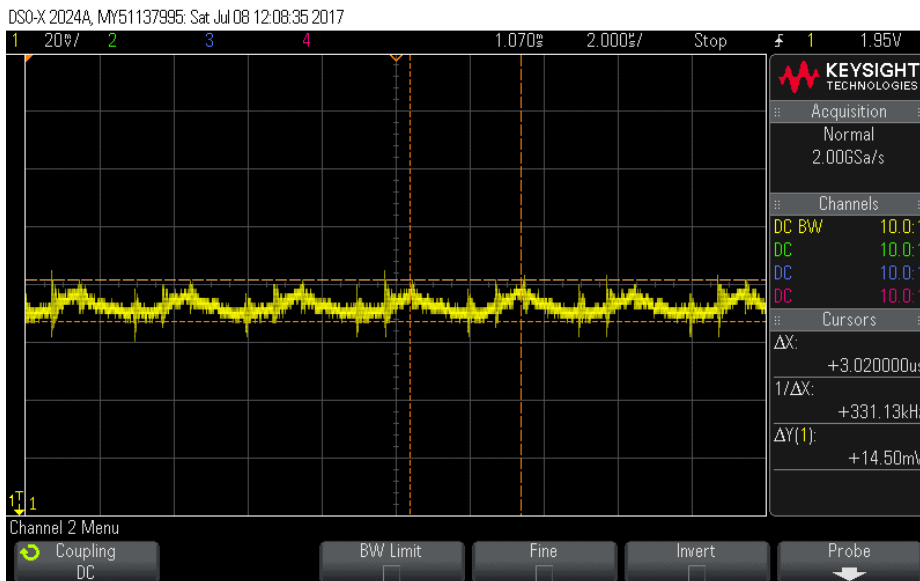

Output ripple current 1A/dev, Resistive Load 40mΩ

MX15-4-100 Laser Driver and Thermal Management Module

100A, 4V, 10Hz output; 10VDC to 36VDC input

Characteristic Curves (continued)

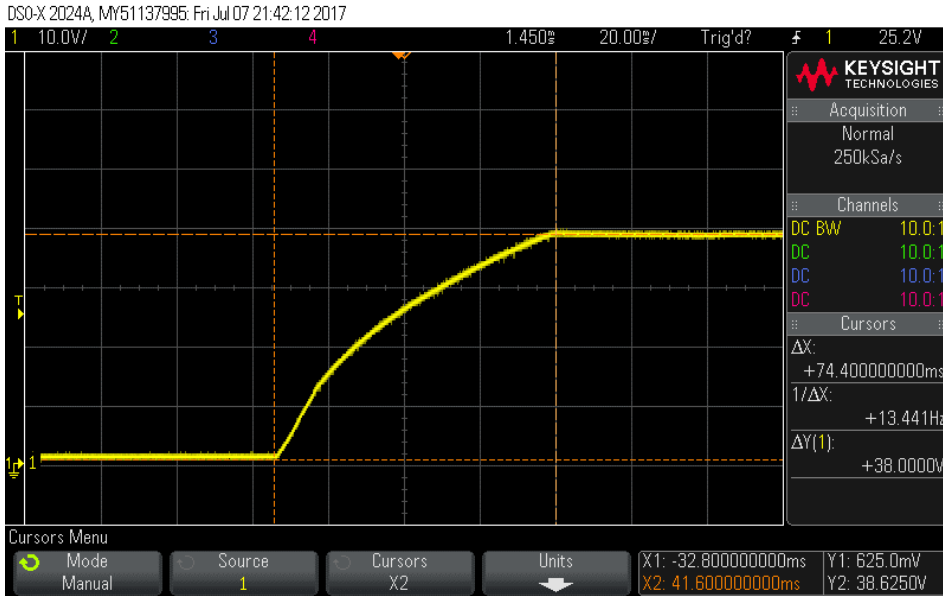

Bulk Capacitor Charging at input voltage 16VDC

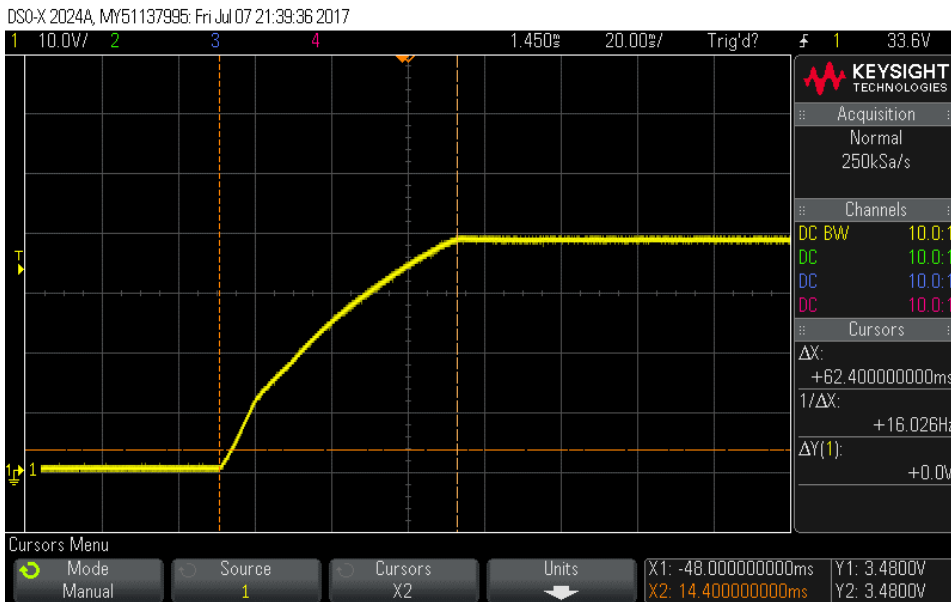

Bulk Capacitor Charging at input voltage 28VDC

MX15-4-100 Laser Driver and Thermal Management Module

100A, 4V, 10Hz output; 10VDC to 36VDC input

Characteristic Curves (continued)

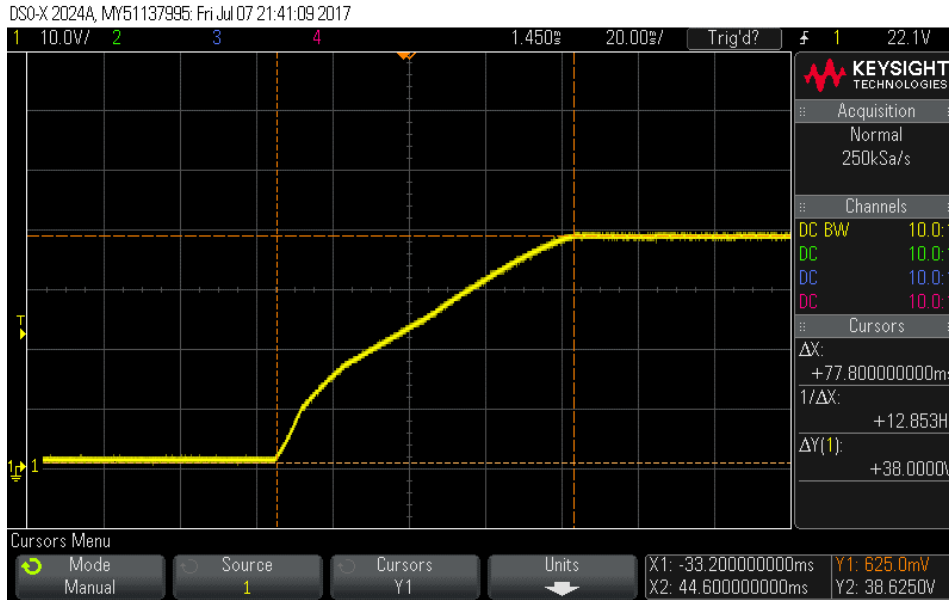

Bulk Capacitor Charging at input voltage 35VDC